

ALUFIX CLASSIC

Quick Change Couplings

Quick change couplings comprise of a top and bottom section, which are aligned accurately together via ball seats. Locking is done with a short turn on a quick fastener. The total height is exactly in Alufix grid. Hinges connect top and bottom sections if required and provide a fold function. The modular design enables following combination possibilities:

Quick change coupling,
Top and bottom sections separately, standard version



Quick change coupling for folding back, hinge is mouted at the rear



Quick change coupling to fold sideways to the left, hinge is mounted on the left



Quick change coupling to fold sideways to the right, hinge is mounted on the right



Quick change coupling with two folding options
One hinge on the left and one at the rear.
Not shown, one hinge on the right, one hinge at the rear



Quick change coupling with three folding options
One hinge on the left, one on the right and one at the rear.

Quick change coupling top section

with hinge bores, complete

Nr.	A (AF)	B	C	
282471	25	15	M6	101
282472	40	24	M10	415
282473	50	30	M12	810
283320	40/25	24	M6	415
283330	50/25	30	M6	810

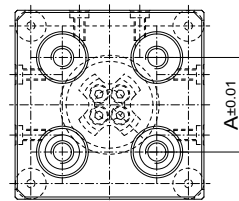
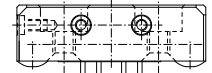
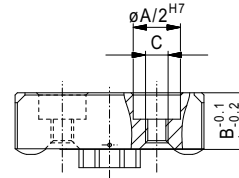
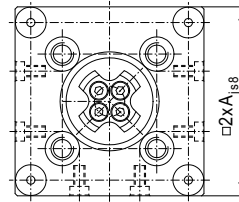

Quick change coupling bottom section

with hinge bores, complete

Nr.	A (AF)	B	
282474	25	10	75
282475	40	16	305
282476	50	20	550

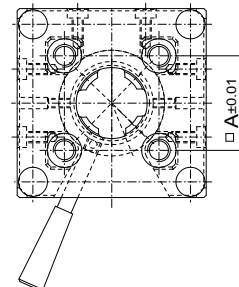
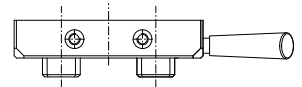
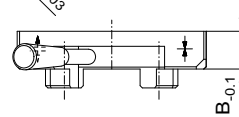
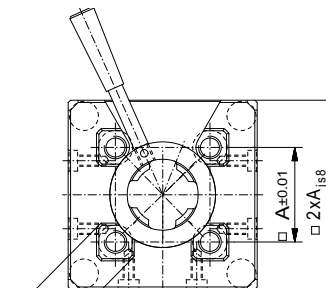

ALUFIX CLASSIC elements can be anodized in different colours. The colour natural is standard, black (-1) is available as an alternative. Other colours on request.

Other versions on request

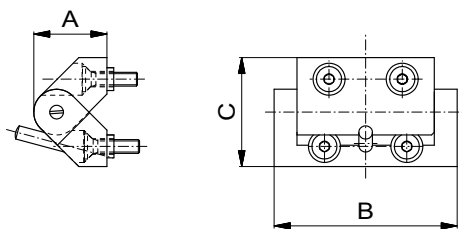

Hinge

for quick change coupling, complete

Nr.	AF	A	B	C	
282386	25	16	40	23,8	18
282387	40	25,6	64	38	91
282388	50	32	80	47,6	140

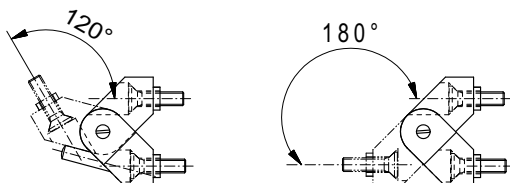

Cylindrical pin limits opening angle to 120°

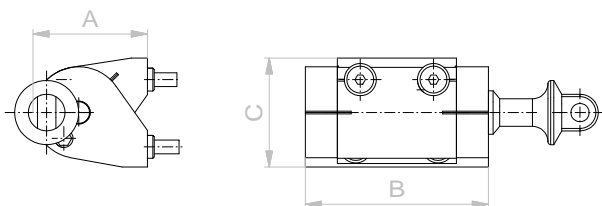

Nr.	AF	A	B	C	
286856	25	25	40	23,8	-
286857	40	36,6	64	38	-
286858	50	43	80	47,6	-

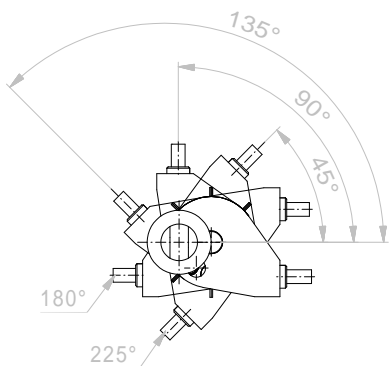

Quick change coupling

Assembly

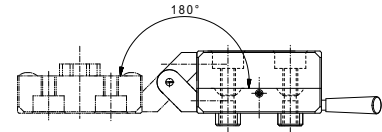
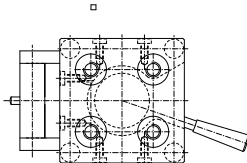
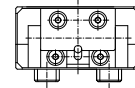
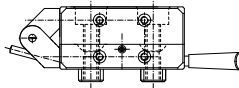
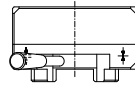
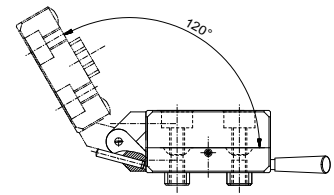
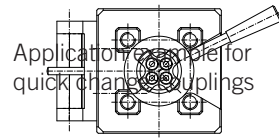

ALUFIX CLASSIC elements can be anodized in different colours. The colour natural is standard, black (-1) is available as an alternative. Other colours on request.

Other versions on request